



深圳市拓普微科技开发有限公司

SHENZHEN TOPWAY TECHNOLOGY CO., LTD.

HKT043ATA-1C

LCD Module User Manual

Prepared by: Liaoliliang Date: 2020-12-30	Checked by: Date:	Approved by: Date:
--	----------------------------------	-----------------------------------

Rev.	Descriptions	Release Date
0.1	- Preliminary Draft release	2017-07-05
0.2	- Assemble Precaution	2017-10-25
0.3	-Update Terminal Function	2020-09-24
0.4	-Add Highlight Description	2020-12-30

Table of Content

1 Basic Specification	3
1.1 General Specification	3
1.2 Block Diagram	3
1.3 Terminal Function	4
1.3.1 RS232 Interface Terminal (K1)	4
1.3.2 USB Interface Terminal (K3).....	4
2 Absolute Maximum Ratings	5
3 Electrical Characteristics	5
3.1 DC Characteristics	5
3.2 AC Characteristic.....	5
4 Function Specifications	6
4.1 Basic Operation Function Descriptions	6
4.2 Quick Start Guide	7
4.3 Command Descriptions	7
5 Optical Characteristics	8
6 Precautions of using LCD Modules	10
7 . Assemble Precaution.....	11

1 Basic Specification

TOPWAY HKT043ATA-1C is a Smart TFT Module with 32bit MCU on board. Its graphics engine provides numbers of outstanding features. It supports TOPWAY TML 3.0(Editor 2017) for preload and pre-design display interface that simplify the host operation and development time. Suitable for industry control, instrumentation, medical electronics, power electric equipment applications.

1.1 General Specification

Screen Size(Diagonal) :	4.3"
Resolution :	480(RGB) x 272
Color Depth :	65k color (16bit)
Pixel Configuration :	RGB Stripe
Display Mode :	Transmissive / Normal White
Viewing Direction :	12H (*1) (gray-scale inverse) 6H (*2)
Outline Dimension :	139 x 97 x 26.9 (mm) (see attached drawing for details)
Active Area :	95.04 x 53.86(mm)
Backlight :	LED
Command I/F:	RS -232C
Surface Treatment :	Anti-Glare Treatment
Operating Temperature :	-20 ~ +70°C
Storage Temperature :	-30 ~ +80°C
Highlight	RTC with battery, Casing, Support 90 degrees rotation, Buzzer

Note:

*1. For saturated color display content (eg. pure-red, pure-green, pure-blue, or pure-colors-combinations).

*2. For "color scales" display content.

*3. Color tone may slightly change by Temperature and Driving Condition.

1.2 Block Diagram

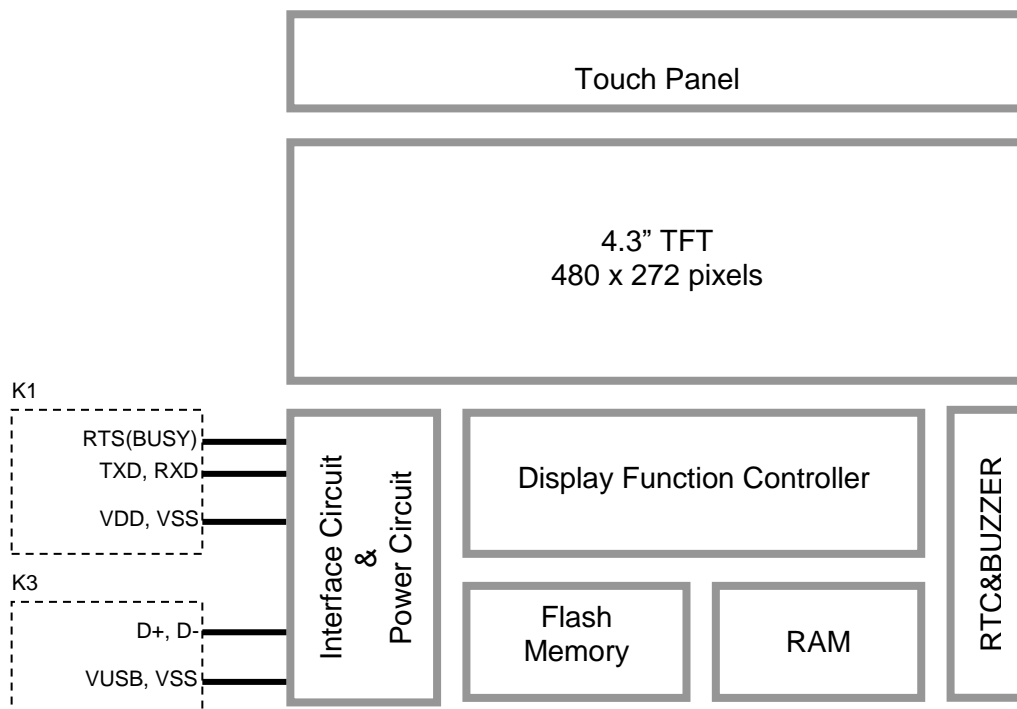

1.3 Terminal Function

1.3.1 RS232 Interface Terminal (K1)

Pin No.	Pin Name	I/O	Descriptions
1	VDD	P	Power supply
2	RXD	I	Data Input (eg.to PC's RS232C pin3<9pin D-connector>)
3	TXD	O	Data output (eg.to PC's RS232C pin2<9pin D-connector>)
4	RTS(BUSY)	O	Request To Send (could function as busy BUSY signal) (eg. to PC's RS232C pin8 <9pin D-connector>)
5	NC	--	NO Connect, leave open
6	VSS	P	Ground, (0V)

Note.

- *1. User data and commands transfer through this terminal
- *2. HW hand shake is suggested

1.3.2 USB Interface Terminal (K3)

Pin No.	Pin Name	I/O	Descriptions
1	VUSB	P	Power output
2	D-	I/O	USB DATA negative signal
3	D+	I/O	USB DATA positive signal
4	NC	--	No connection, leave open
5	VSS	P	Ground, (0V)

Note.

- *1. TML files and image files preload through this terminal

2 Absolute Maximum Ratings

Items	Symbol	Min.	Max.	Unit	Condition
Power Supply voltage	V_{DD}	-0.3	28	V	
Operating Temperature	T_{OP}	-20	70	°C	No Condensation
Storage Temperature	T_{ST}	-30	80	°C	No Condensation

Note:

- *1. This rating applies to all parts of the module and should not be exceeded.
- *2. The operating temperature only guarantees operation of the circuit. The contrast, response speed, and the other specification related to electro-optical display quality is determined at the room temperature, $T_{OP}=25^{\circ}\text{C}$
- *3. Ambient temperature when the backlight is lit (reference value)
- *4. Any Stresses exceeding the Absolute Maximum Ratings may cause substantial damage to the device. Functional operation of this device at other conditions beyond those listed in the specification is not implied and prolonged exposure to extreme conditions may affect device reliability.

3 Electrical Characteristics

3.1 DC Characteristics

$V_{DD}=12\text{V}, V_{SS}=0\text{V}, T_{OP}=25^{\circ}\text{C}$

Items	Symbol	MIN.	TYP.	MAX.	Unit	Applicable Pin
Operating Voltage	V_{DD}	6	12.0	26	V	VDD
RxD Input MARK(1)	V_{RXDM}	-3.0	-	-15.0	V	Rx
RxD Input SPACE(0)	V_{RXDS}	+3.0	-	+15.0	V	Rx
TxD Output MARK(1)	V_{TXDM}	-3.0	-	-15.0	V	Tx
TxD Output SPACE(0)	V_{TXDS}	+3.0	-	+15.0	V	Tx
RTS Output High	V_{TXDH}	-3.0	-	-15.0	V	RTS(BUSY)
RTS Output Low	V_{TXDL}	+3.0	-	+15.0	V	RTS(BUSY)
Operating Current	I_{DD}	-	175	-	mA	VDD (*1)
Battery Supply Current	I_{BAT}	-	0.6	-	uA	

Note.

- *1. Normal display condition and no usb connect.

3.2 AC Characteristic

Items	JP6,JP8=close, JP5,JP7=open (factory default)	JP6,JP7=close, JP5,JP8=open	JP6,JP7= open, JP5,JP8= close	JP6,JP8= open, JP5,JP7= close
Start bit	1	1	1	1
Data bit	8	8	8	8
Parity bit	None	None	Even	Odd
Stop bit	1	1	1	1
Baud Rate(*1)	115200 bps	9600 bps	115200 bps	115200 bps

Items	JP10=close, JP9=open (factory default)	JP10= open, JP9=close
Serial Data Flow Control	busy	Xon/Xoff

Note.

- *1.Baud Rate (1200bps~115200bps) could be adjusted by software.

4 Function Specifications

4.1 Basic Operation Function Descriptions

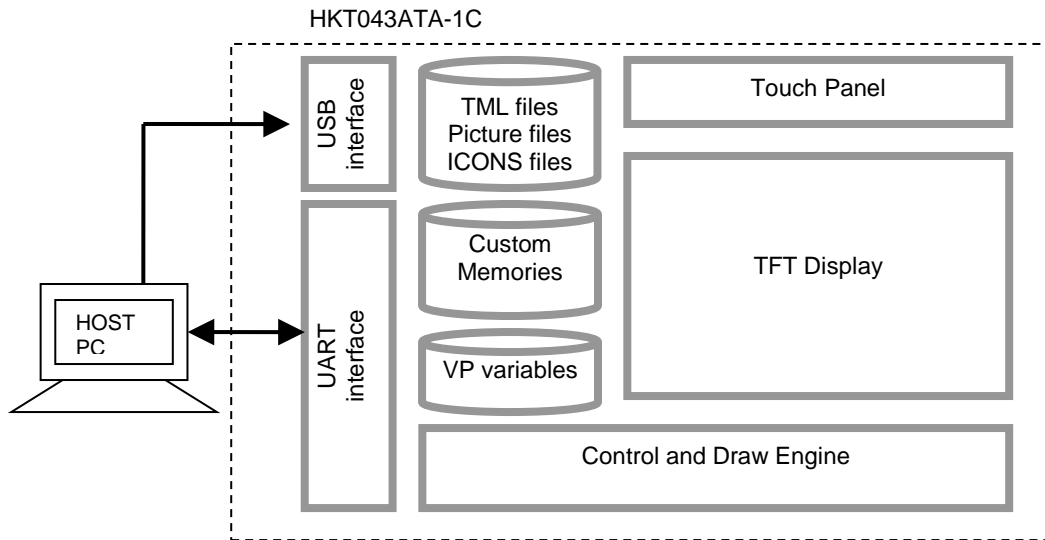

- TML files, Picture files, ICON files are stored inside FLASH memory area. They are preloaded to HKT043ATA-1C for stand alone interface use.
- Those files are preloaded via USB interface as an USB drive.
- All the interface flow and the touch response are based on the preloaded TML files
- VP variables memory is inside RAM area, it provides real time access via UART by the HOST or display onto the TFT by TML file.
- Custom Memories are inside FLASH memory area It can be accessed via UART interface by the HOST.
- Control and Draw Engine executes HOST commands and response respectively
- It also reports the real time Touch Key number to the HOST

4.2 Quick Start Guide

1. Install TOPWAY Graphics Editor

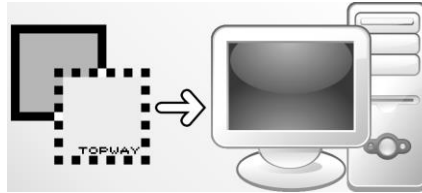

2. Import pictures design UI flow

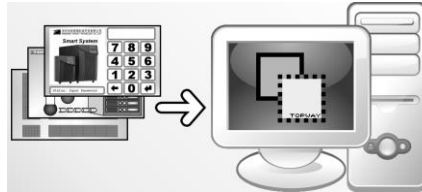

3. Download to Smart LCD

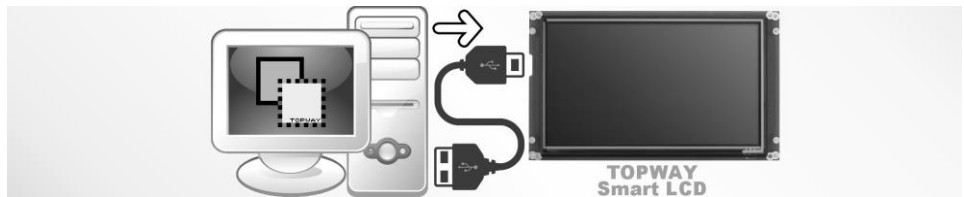

4. power on & display



5. Connect to host Show real time data



4.3 Command Descriptions

Please refer to "SMART LCD Command Manual".

5 Optical Characteristics

Item	Symbol	Condition	Min	Typ	Max	Unit	Remark
View Angles	θT	CR ≥ 10	70	80	-	Degree	Note2,3
	θB		50	60	-		
	θL		70	80	-		
	θR		70	80	-		
Contrast Ratio	CR	θ = 0°	700	900	-		Note 3
Response Time	T _{ON}	25°C	-	20	30	ms	Note 4
	T _{OFF}						
Chromaticity	White	Backlight is on	x	0.255	0.305	0.355	Note 1,5
			y	0.277	0.327	0.377	
	Red		x	0.534	0.584	0.634	Note 1,5
			y	0.300	0.350	0.400	
	Green		x	0.290	0.340	0.390	Note 1,5
			y	0.543	0.593	0.643	
	Blue		x	0.102	0.152	0.202	Note 1,5
			y	0.040	0.090	0.140	
Uniformity	U		75	80	-	%	Note 6
NTSC			45	50	-	%	Note 5
Luminance	L		-	280	-	cd/m ²	Note 7

1. IF = 40 mA, and the ambient temperature is 25°C.
2. The test systems refer to Note 1 and Note 2.

Note 1:
 The data are measured after LEDs are turned on for 5 minutes. LCM displays full white. The brightness is the average value of 9 measured spots. Measurement equipment SR-3A (1°)
 Measuring condition:
 - Measuring surroundings: Dark room
 - Measuring temperature: Ta=25°C.
 - Adjust operating voltage to get optimum contrast at the center of the display.

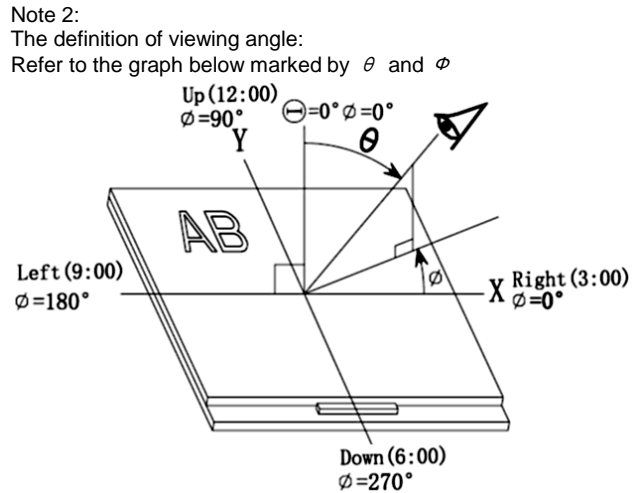

Note 3:
 The definition of contrast ratio (Test LCM using SR-3A (1°)):

$$\text{Contrast Ratio (CR)} = \frac{\text{Luminance When LCD is at "White" state}}{\text{Luminance When LCD is at "Black" state}}$$
 (Contrast Ratio is measured in optimum common electrode voltage)

Note 4:
 Definition of Response time. (Test LCD using BM-7A(2°)):
 The output signals of photo detector are measured when the input signals are changed from "black" to "white"(falling time) and from "white" to "black"(rising time), respectively. The response time is defined as the time interval between the 10% and 90% of amplitudes. Refer to figure as below.

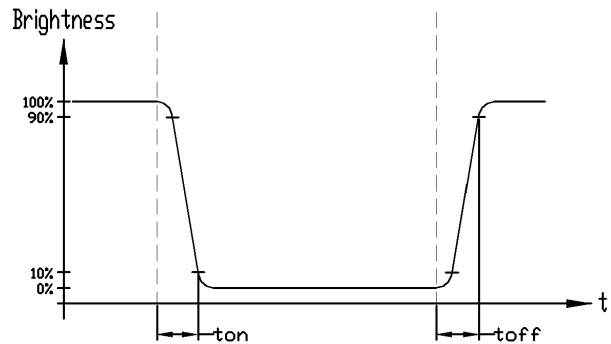

Note 5:
 Definition of Color of CIE1931 Coordinate and NTSC Ratio.

Color gamut:

$$S = \frac{\text{Area of RGB triangle}}{\text{Area of NTSC triangle}} \times 100\%$$

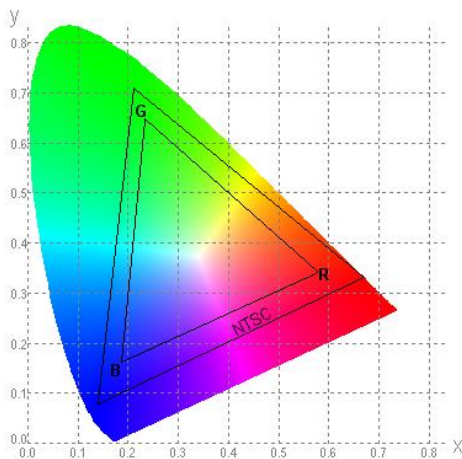

Note 6:
 The luminance uniformity is calculated by using following formula.

$$\Delta Bp = Bp (\text{Min.}) / Bp (\text{Max.}) \times 100 (\%)$$

$$Bp (\text{Max.}) = \text{Maximum brightness in 9 measured spots}$$

$$Bp (\text{Min.}) = \text{Minimum brightness in 9 measured spots.}$$

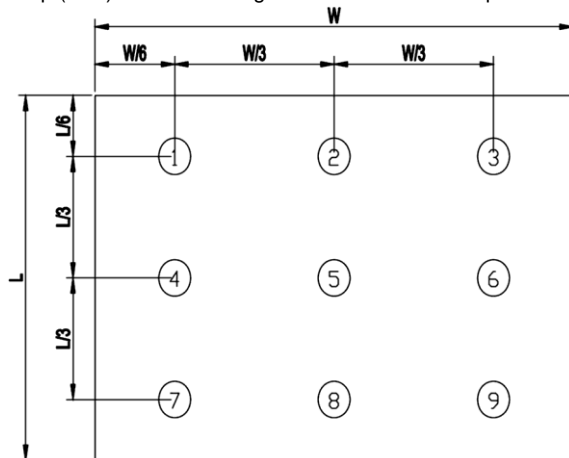

Note 7:
 Measured the luminance of white state at center point

6 Precautions of using LCD Modules

Mounting

- Mounting must use holes arranged in four corners or four sides.
- The mounting structure so provide even force on to LCD module. Uneven force (ex. Twisted stress) should not applied to the module. And the case on which a module is mounted should have sufficient strength so that external force is not transmitted directly to the module.
- It is suggested to attach a transparent protective plate to the surface in order to protect the polarizer. It should have sufficient strength in order to the resist external force.
- The housing should adopt radiation structure to satisfy the temperature specification.
- Acetic acid type and chlorine type materials for the cover case are not desirable because the former generates corrosive gas of attacking the polarizer at high temperature and the latter causes circuit break by electro-chemical reaction.
- Do not touch, push or rub the exposed polarizers with glass, tweezers or anything harder than HB pencil lead. Never rub with dust clothes with chemical treatment. Do not touch the surface of polarizer for bare hand or greasy cloth.(Some cosmetics deteriorate the polarizer.)
- When the surface becomes dusty, please wipe gently with absorbent cotton or other soft materials like chamois soaks with petroleum benzine. Normal-hexane is recommended for cleaning the adhesives used to attach front / rear polarizers. Do not use acetone, toluene and alcohol because they cause chemical damage to the polarizer.

Operating

- The spike noise causes the mis-operation of circuits. It should be within the $\pm 200\text{mV}$ level (Over and under shoot voltage)
- Response time depends on the temperature.(In lower temperature, it becomes longer.)
- Brightness depends on the temperature. (In lower temperature, it becomes lower.) And in lower temperature, response time(required time that brightness is stable after turned on) becomes longer.
- Be careful for condensation at sudden temperature change. Condensation makes damage to polarizer or electrical contacted parts. And after fading condensation, smear or spot will occur.
- When fixed patterns are displayed for a long time, remnant image is likely to occur.
- Module has high frequency circuits. Sufficient suppression to the electromagnetic interference shall be done by system manufacturers. Grounding and shielding methods may be important to minimized the interference

Electrostatic Discharge Control

Since a module is composed of electronic circuits, it is not strong to electrostatic discharge. Make certain that treatment persons are connected to ground through wrist band etc. And don't touch interface pin directly.

Strong Light Exposure

Strong light exposure causes degradation of polarizer and color filter.

Storage

When storing modules as spares for a long time, the following precautions are necessary.

- Store them in a dark place. Do not expose the module to sunlight or fluorescent light. Keep the temperature between 5°C and 35°C at normal humidity.
- The polarizer surface should not come in contact with any other object. It is recommended that they be stored in the container in which they were shipped.

Protection Film

- When the protection film is peeled off, static electricity is generated between the film and polarizer. This should be peeled off slowly and carefully by people who are electrically grounded and with well ion-blown equipment or in such a condition, etc.
- The protection film is attached to the polarizer with a small amount of glue. If some stress is applied to rub the protection film against the polarizer during the time you peel off the film, the glue is apt tore main on the polarizer. Please carefully peel off the protection film without rubbing it against the polarizer.
- When the module with protection film attached is stored for a long time, sometimes there remains a very small amount of glue still on the polarizer after the protection film is peeled off.
- You can remove the glue easily. When the glue remains on the polarizer surface or its vestige is recognized, please wipe them off with absorbent cotton waste or other soft material like chamois soaked with normal-hexane.

Transportation

The LCD modules should be no falling and violent shocking during transportation, and also should avoid excessive press, water, damp and sunshine.

7 . Assemble Precaution

安装注意事项

- Customer front panel opening and thickness for TOPWAY display module should be fit for its assembling and sealing.
 - The suggested assemble gap(A) should be about 0.3~0.5mm on each side.
 - The suggested front panel thickness(B) should be about 1.5~4.0mm.

客户面板开窗及厚度应适合 TOPWAY 显示模块的安装及密封。

- 建议每边安装间隙(A)约为 0.3 ~0.5mm.
- 建议面板厚度(B) 约为 1.5~4.0mm.

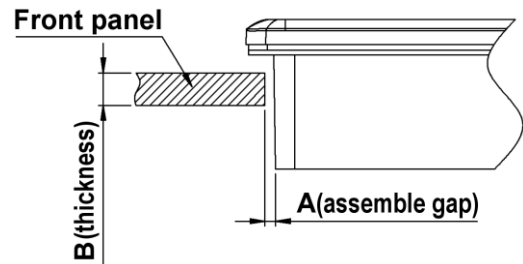

- A silicon sealing ring ships with TOPWAY display module. It should be in place before assembling to the front panel.

TOPWAY 显示模块上的硅胶密封圈在安装时确保嵌入到位。

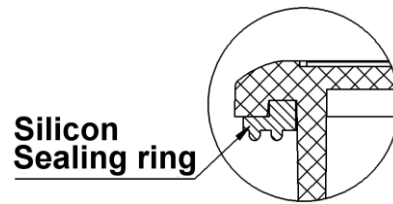

- It should fix the TOPWAY display module into the front panel with two steps.
 - Pre-fixing: Slightly tighten the screws on beam clamp in sequence as picture on the right side.
 - Final-fixing: Tighten the fixing screws on beam clamp in sequence as well with twist torque about 4~6kg.cm (*1) . and put the beam clamp straight.

Note:

*1. Over tightening might damage the shell and cause bad

sealing result.

应分两步将 TOPWAY 显示模块固定在面板上。

- 预紧: 将卡扣螺钉按右图所示顺序稍加预紧.
- 紧定: 再次按顺序用 **4~6kg.cm** 扭力拧紧卡扣螺钉(* 1),并注意卡扣置正无歪斜.

注:

*1. 过度拧紧可能会损坏外壳和影响密封效果.

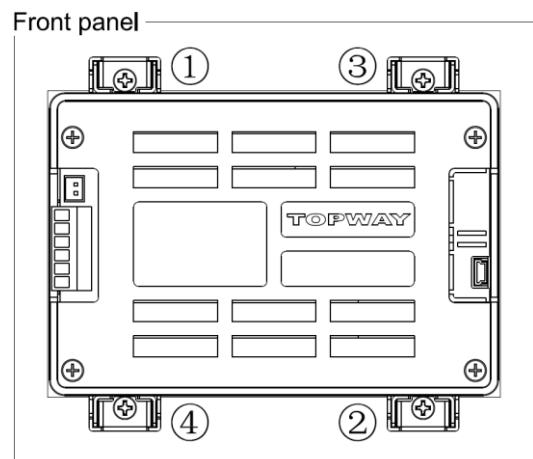

- It is strongly suggested to check the seal balancing of the four-side of the TOPWAY display module.
 - The suggested after assemble sealed gap(C) should be about 0.8~1.2mm.

需注意检查 TOPWAY 显示模块四周在安装后保证平衡密封。

- 建议组装后的密封间隙(C)约为 0.8 ~1.2 mm.

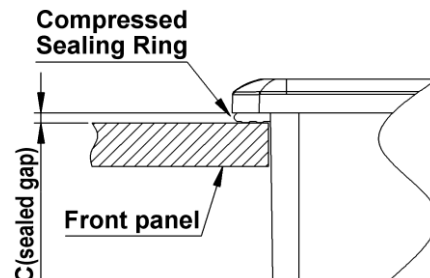

- Others:

- Never hot plug the device! Power off the device before connect or disconnect the display module.
- Don't forget to remove the cover protective film for normal operation.

其它:

- 视频线禁止带电插拔! 在连接或断开显示模块之前先关闭设备电源.
- 使用前请揭去保护膜.



深圳市拓普微科技开发有限公司

SHENZHEN TOPWAY TECHNOLOGY CO., LTD.

SMART LCD

Command V5.04 Manual

Prepared by: liu Date: 2017-07-24	Checked by: Date:	Approved by: Date:
--	----------------------------------	-----------------------------------

Rev.	Descriptions	Release Date
0.1	- Preliminary Draft release	2016-11-02
0.2	- Add a description of the 0xE8 command	2017-01-12
0.3	- 4.1, 0xE2, 0xE3 command name correction	2017-05-26
0.4	- Add a description of the 0xE7 command	2017-07-24

Table of Content

1	Basic Specifications	3
1.1	Hardware connection	3
2	Command Structure	3
2.1	Communication Packet Structure	3
2.2	Packet Acknowledgment	3
3	Data arrangement	4
3.1	Color Data Value Configuration	4
3.2	Data / Address / Page_ID / Location Values Configuration.....	4
4	Command Descriptions	5
4.1	Command table	5
4.2	Config/ Status Function Commands Details.....	6
4.2.1	hand_shake (0x30)	6
4.2.2	read_version (0x31)	6
4.2.3	read_pg_id (0x32)	7
4.2.4	touch_response (0x72/ 0x73/ 0x77/ 0x78/ 0x79).....	7
4.2.5	set_sys_config (0xE0).....	8
4.2.6	sel_project (0xE1)	9
4.2.7	touch_calib (0xE4)	9
4.2.8	screen_saver (0x5E).....	9
4.2.9	backlight_ctrl (0x5F).....	9
4.2.10	buzzer_touch_sound (0x79)	9
4.2.11	buzzer_ctrl (0x7A)	9
4.2.12	Flash_write (0x90)	10
4.2.13	Flash_read (0x91)	10
4.2.14	RTC_read (0x9B)	10
4.2.15	RTC_set (0x9C)	11
4.2.16	USR_bin_read (0x93)	11
4.2.17	U_drv_format (0xE2)	11
4.2.18	U_drv_unlock (0xE3)	11
4.3	Display Control Function Commands Details	12
4.3.1	disp_page (0x70)	12
4.3.2	set_element_fg (0x7E)	12
4.3.3	set_element_bg (0x7F)	12
4.3.4	Set_codepage (0xE7)	12
4.3.5	suspend_vp_refresh (0xE8).....	13
4.4	VP Function Commands Details.....	13
4.4.1	Successive_write (0x82)	13
4.4.2	Successive_read (0x83)	13
4.4.3	BP1_write (0x4B)	14
4.4.4	BP1_write_compress (0x4C)	14
4.4.5	G16_write (0x4D)	15
4.4.6	G16_write_rotate (0x4E)	15
4.4.7	System Register Write (0x3B)	15
4.4.8	System Register Read (0x3C)	16
4.4.9	STR_write (0x42)	16
4.4.10	STR_read (0x43)	16
4.4.11	STR_fill (0x46)	17
4.4.12	N16_write (0x3D)	17
4.4.13	N16_read (0x3E)	17
4.4.14	N16_fill (0x3F)	17
4.4.15	N32_write (0x44)	18
4.4.16	N32_read (0x45)	18
4.4.17	N32_fill (0x47)	18
4.4.18	N64_write (0x48)	19
4.4.19	N64_read (0x49)	19
4.4.20	N64_fill (0x4A)	19

1 Basic Specifications

TOPWAY Smart LCD serial command is for real-time control and access. Host machine get the data which input through the Smart LCD interface or provide the data for display.

1.1 Hardware connection

Smart LCD serial UART interface are mainly base on RS232-C standard, by default, config as 8N1 115200bps.

2 Command Structure

2.1 Communication Packet Structure

Commands and Response Packet should be format as follow (host → module):

Seq	Code	Code type	Description
1	0xAA	Packet header	1byte
2	Cmd-code	Command code	1byte
3	Par-data	Parameter or Data	(*1)
:	:	-	-
:	:	-	-
:	:	-	-
N-3 th	0xCC	Packet tail	4byte
N-2 th	0x33		
N-1 th	0xC3		
N th	0x3C		

Note.

*1. Unless otherwise specified, all the multi-byte values, data, address' byte sequence are MSB first, LSB last.

2.2 Packet Acknowledgment

Packet Acknowledgment is two byte in ASCII (module → host):

Response	code	Description
Command (in packet) executed and wait for next Command	":>"	In ASCII (0x3a, 0x3e)
Command (in packet) error and wait for next Command	"!>"	In ASCII (0x21,0x3e)

Note.

*1. Packet Acknowledgement response to a valid packet only.

3 Data arrangement

3.1 Color Data Value Configuration

16 bit Color value

16 bit color value															
R4	R3	R2	R1	R0	G5	G4	G3	G2	G1	G0	B4	B3	B2	B1	B0
High byte (MSB)								Low byte (LSB)							
D7	D6	D5	D4	D3	D2	D1	D0	D7	D6	D5	D4	D3	D2	D1	D0

3.2 Data / Address / Page_ID / Location Values Configuration

64bit value

64 bit number value							
D63...D56	D55...D48	D47...D40	D39..D32	D31...D24	D23...D16	D15...D8	D7...D0
Byte7 (MSB)							Byte0 (LSB)
D7...D0	D7...D0	D7...D0	D7...D0	D7...D0	D7...D0	D7...D0	D7...D0

32bit value

32 bit number value			
D31...D24	D23...D16	D15...D8	D7...D0
Byte3 (MSB)			Byte0 (LSB)
D7...D0	D7...D0	D7...D0	D7...D0

16bit value

16 bit number value	
D15...D8	D7...D0
High Byte (MSB)	Low Byte (LSB)
D7...D0	D7...D0

4 Command Descriptions

4.1 Command table

Functions	Name	Code	Description	
Config/ Status Functions	hand_shake	0x30	Read a Hand Shake	
	read_version	0x31	Read firmware version	
	read_pg_id	0x32	Read Current page ID	
	touch_response	0x72/0x73/ 0x77/0x78/ 0x79	see also set_sys_config	
	set_sys_config	0xE0	System parameter configuration and Baud Rate	
	sel_project	0xE1	Specify operating project folder	
	touch_calib	0xE4	Touch panel calibration	
	screen_saver	0x5E	Screen saver (backlight dim down time out)	
	backlight_ctrl	0x5F	backlight brightness control (64 levels)	
	buzzer_touch_sound	0x79	buzzer enable time length (in 10ms step)	
	buzzer_ctrl	0x7A	Buzzer control	
	Flash_write	0x90	Write data to the flash	
	Flash_read	0x91	Read data from the flash	
	RTC_read	0x9B	Read the RTC values	
	RTC_set	0x9C	Set the RTC	
	USR_bin_read	0x93	Read data from the USR_bin	
	U_drv_format	0xE2	Format the U_drv	
	U_drv_unlock	0xE3	Unlock the U_drv with pre-stored password	
	Display Control Functions	disp_page	0x70	Display a pre-stored TML file (page)
		set_element_fg	0x7E	Set the foreground color of STR, N16, N32 or N64
set_element_bg		0x7F	Set the background color of STR, N16, N32 or N64	
set_codepage		0xE7	Sets country character set and code-page character set	
suspend_vp_fresh		0xE8	Set the screen to pause the refresh and deactivate the touchkey or release the pause to refresh and enable the touchkey	
VP Functions	Successive_write	0x82	Write successive value to VP_N16, VP_N32, VP_N64	
	Successive_read	0x83	Read successive value from VP_N16, VP_N32, VP_N64	
	BP1_write	0x4B	Write bit-map (1bpp) data to VP_BP1	
	BP1_write_comp	0x4C	Write compressed bit-map (1bpp) data to VP_BP1	
	G16_write	0x4D	Write 16bit (signed integer) graphic array to VP_G16	
	G16_write_rotate	0x4E	Rotate the VP_G16 array data inside the module and write a 16bit (signed integer) value into end-of-array	
	System Register Write	0x3B	Write System Register	
	System Register Read	0x3C	Read System Register	
	STR_write	0x42	Write string to VP_STR	
	STR_read	0x43	Read string form VP_STR	
	STR_fill	0x46	Fill strings to the VP_STR	
	N16_write	0x3d	Write 16bit (signed integer) value to VP_N16	
	N16_read	0x3e	Read 16bit (signed integer) value from VP_N16	
	N16_fill	0x3f	Fill numbers to the VP_N16	
	N32_write	0x44	Write 32bit (signed integer) value to VP_N32	
	N32_read	0x45	Read 32bit (signed integer) value from VP_N32	
	N32_fill	0x47	Fill numbers to the VP_N32	
	N64_write	0x48	Write 64bit (signed integer) value to VP_N64	
	N64_read	0x49	Read 64bit (signed integer) value from VP_N64	
	N64_fill	0x4A	Fill numbers to the VP_N64	

4.2 Config/ Status Function Commands Details

4.2.1 hand_shake (0x30)

seq	Cmd-code / Par-data	Descriptions
1	0x30	Read a Hand Shake

Note.

*1. Command should be transferred in communication packet structure (see Communication Packet Structure Section for details)

Response code:

Seq.	Content	Byte in Hex	Descriptions	
1 st	Header	0xAA	Communication packet header	
2 nd	Command	0x30	Command executed	
3 rd	"T"	0x54	"Topway HMT Ready\0" in ASCII	
4 th	"o"	0x6f		
5 th	"P"	0x70		
6 th	"w"	0x77		
7 th	"a"	0x61		
8 th	"y"	0x79		
9 th	" "	0x20		
10 th	"H"	0x48		
11 th	"M"	0x4d		
12 th	"T"	0x54		
13 th	" "	0x20		
14 th	"R"	0x52		
15 th	"e"	0x65		
16 th	"a"	0x61		
17 th	"d"	0x64		
18 th	"y"	0x79		'\0'(0x00): string end mark
19 th	\0	0x00		
20 th	Tail	0xCC	Communication packet tail	
21 st		0x33		
22 nd		0xC3		
23 rd		0x3C		

Note.

*1. The Response code with communication packet format (see Communication Packet Structure Section for details)

4.2.2 read_version (0x31)

Seq	Cmd-code / Par-data	Descriptions
1	0x31	Read firmware version

Note.

*1. Command should be transferred in communication packet structure (see Communication Packet Structure Section for details)

Response code:

Seq.	Content	Byte in Hex	Descriptions
1 st	Header	0xAA	Communication packet header
2 nd	Command	0x31	Command executed
3 rd	"1"	0x31	"1.06\0" in ASCII Where firmware version is V1.06(example)
4 th	"."	0x2e	
5 th	"0"	0x30	
6 th	"6"	0x36	
7 th	\0	0x00	'\0'(0x00): string end mark
8 th	Tail	0xCC	Communication packet tail
9 th		0x33	
10 th		0xC3	
11 th		0x3C	

Note.

*1. The Response code with communication packet format (see Communication Packet Structure Section for details)

4.2.3 read_pg_id (0x32)

Seq	Cmd-code / Par-data	Descriptions
1	0x32	Read Current page ID

Note.

*1. Command should be transferred in communication packet structure (see Communication Packet Structure Section for details)

Response code:

Seq.	Content	Byte in Hex	Descriptions
1 st	Header	0xAA	Communication packet header
2 nd	Command	0x32	Command executed
3 rd	Page ID	Page_IDh	Current Page ID in 16bit binary value
4 th		Page_IDl	
5 th	Tail	0xCC	Communication packet tail
6 th		0x33	
7 th		0xC3	
8 th		0x3C	

Note.

*1. The Response code with communication packet format (see Communication Packet Structure Section for details)

4.2.4 touch_response (0x72/ 0x73/ 0x77/ 0x78/ 0x79)

seq	Cmd-code / Par-data	Descriptions
1	--	Use set_sys_config to config the functions

Touch Release Coordinate Response code (0x72):

Seq.	Content	Byte in Hex	Descriptions
1 st	Header	0xAA	Communication packet header
2 nd	Command	0x72	Touched release Coordinate
3 rd	X coordinate	Xh	Coordinate in 16bit binary value X = horizontal coordinate Y = vertical coordinate
4 th		Xl	
5 th	Y coordinate	Yh	Communication packet tail
6 th		Yl	
7 th	Tail	0xCC	Communication packet tail
8 th		0x33	
9 th		0xC3	
10 th		0x3C	

Note.

*1. The Response code with communication packet format (see Communication Packet Structure Section for details)

Touch Down Coordinate Response code (0x73):

Seq.	Content	Byte in Hex	Descriptions
1 st	Header	0xAA	Communication packet header
2 nd	Command	0x73	Touched down Coordinate
3 rd	X coordinate	Xh	Coordinate in 16bit binary value X = horizontal coordinate Y = vertical coordinate
4 th		Xl	
5 th	Y coordinate	Yh	Communication packet tail
6 th		Yl	
7 th	Tail	0xCC	Communication packet tail
8 th		0x33	
9 th		0xC3	
10 th		0x3C	

Note.

*1. The Response code with communication packet format (see Communication Packet Structure Section for details)

Touch Key ID Response code (0x78):

Seq.	Content	Byte in Hex	Descriptions
1 st	Header	0xAA	Communication packet header
2 nd	Command	0x78	Touched release Key_ID defined by TOPWAY TML Graphic Editor will be response to host
3 rd	Page_ID	Page_IDh	Page_ID = the touch key in page(16bit binary value)
4 th		Page_IDl	
5 th	Y coordinate	Key_ID	Key_ID (8bit binary value)
6 th	Tail	0xCC	Communication packet tail
7 th		0x33	
8 th		0xC3	
9 th		0x3C	

Note.

*1. The Response code with communication packet format (see Communication Packet Structure Section for details)

Touch Key ID Response code (0x79):

Seq.	Content	Byte in Hex	Descriptions
1 st	Header	0xAA	Communication packet header
2 nd	Command	0x79	Touched down Key_ID defined by TOPWAY TML Graphic Editor will be response to host
3 rd	Page_ID	Page_IDh	Page_ID = the touch key in page(16bit binary value)
4 th		Page_IDl	
5 th	Y coordinate	Key_ID	Key_ID (8bit binary value)
6 th	Tail	0xCC	Communication packet tail
7 th		0x33	
8 th		0xC3	
9 th		0x3C	

Note.

*1. The Response code with communication packet format (see Communication Packet Structure Section for details)

Touch Key VP_ADD+VP_Value Response code (0x77):

Seq.	Content	Byte in Hex	Descriptions
1 st	Header	0xAA	Communication packet header
2 nd	Command	0x77	Touch Key VP_ADD+VP_Value Response code
3 rd	VP_ADD	Addr3 (MSB)	VP Address 0x080000 ~ 0x08FFFF:VP_N16 Address 0x020000 ~ 0x02FFFF:VP_N32 Address 0x030000 ~ 0x03FFFF:VP_N64 Address 0x000000 ~ 0x01FFFF:VP_STR Address
4 th		Addr2	
5 th		Addr1	
6 th		Addr0(LSB)	
7 th	Data	:	No.of byte
:		:	VP_N16: 2byte
:		:	VP_N32: 4byte
:		:	VP_N64: 8byte
:	Tail	:	VP_STR: string (with end mark ('\0'(0x00)))
:		0xCC	Communication packet tail
:		0x33	
:		0xC3	
:	0x3C		

Note.

*1. The Response code with communication packet format (see Communication Packet Structure Section for details)

4.2.5 set_sys_config (0xE0)

seq	Cmd-code / Par-data	Descriptions
1	0xE0	Baud Rate and system parameter configuration
2	0x55	
3	0xAA	
4	0x5A	
5	0xA5	
6	Baud_Set	Baudrate Set: 0x00 = 1200bps 0x01 = 2400bps 0x02 = 4800bps 0x03 = 9600bps 0x04 = 19200bps 0x05 = 38400bps 0x06 = 57600bps 0x07 = 115200bps
7	sys_par1	Bit7 = 0: Touch panel function disable Bit7 = 1: Touch panel functions enable (*3)(default) Bit[1..0]: Touch actions configuration (*2, *3)
8	0x00	Reserved

Note.

*1. Command should be transferred in communication packet structure (see Communication Packet Structure Section for details)

*2. Touch panel configuration:

Sys_par1 Bit7	Sys_par1 Bit1	Sys_par1 Bit0	Response To host	Descriptions
0	0	0	Null	Not touch panel functions
1	0	1	Coordinates	Touch down Coordinate will be response to host
1	1	0	Coordinates	Touch release Coordinate will be response to host
1	1	1	Key ID	Touch Key_ID defined by TOPWAY TML Graphic Editor will be response to host

*3. see set_touch section for response code

4.2.6 sel_project (0xE1)

seq	Cmd-code / Par-data	Descriptions
1	0xE1	Select project folder
2	Prj_ID	0~9, project ID 0: System execute the default project "THMT" 1~9: System execute the project "THMT01"~"THMT09"

Note.

*1. Command should be transferred in communication packet structure (see Communication Packet Structure Section for details)

4.2.7 touch_calib (0xE4)

seq	Cmd-code / Par-data	Descriptions
1	0xE4	Touch panel calibration
2	0x55	
3	0xAA	
4	0x5A	
5	0xA5	

Note.

*1. Command should be transferred in communication packet structure (see Communication Packet Structure Section for details)

*2. Keep pressing the touch panel during power on, could also trigger the touch_calib function

4.2.8 screen_saver (0x5E)

seq	Cmd-code / Par-data	Descriptions
1	0x5E	Screen saver
2	Time1h	time out time in seconds, range: 0x0000 ~ 0xffff (0x0000: disable screen saver function) (*2)
3	Time1l	
4	PWM_LE	PWM_LE = 0 ~ 0x3F (default 0x19 in dim down), the backlight dimmed level in screen saving mode (*2) Screensavers brightness can not be greater than the backlight brightness.

Note.

*1. Command should be transferred in communication packet structure (see Communication Packet Structure Section for details)

*2. default value defined by TML graphic editor configuration

4.2.9 backlight_ctrl (0x5F)

seq	Cmd-code / Par-data	Descriptions
1	0x5F	backlight brightness control
2	PWM_LE	PWM_LE=0x00 ~ 0x3F (*2)

Note.

*1. Command should be transferred in communication packet structure (see Communication Packet Structure Section for details)

*2. default value defined by TML graphic editor configuration

4.2.10 buzzer_touch_sound (0x79)

seq	Cmd-code / Par-data	Descriptions
1	0x79	buzzer touch sound control
2	Time	Sounding time length (in 10ms), range 0x00~0x3F 0x00= disable (*2)

Note.

*1. Command should be transferred in communication packet structure (see Communication Packet Structure Section for details)

*2. default value defined by TML graphic editor configuration

4.2.11 buzzer_ctrl (0x7A)

seq	Cmd-code / Par-data	Descriptions
1	0x7A	Buzzer control
2	Loop count	Loop count, Range: 0x01 ~ 0xFF. 0xFF = buzzer infinite loop
3	T1	Buzzer play time 1 Range: 0x00 ~ 0xFF (0~25.5s)(unit 100ms)
4	T2	Buzzer play time 2 Range: 0x00 ~ 0xFF (0~25.5s)(unit 100ms)
5	Freq1	T1 time Buzzer frequency, Unit 100 Hz Ranges: 0x05 ~ 0x32 (500Hz ~ 5KHz) 0x00 = T1 time period buzzer turn off
6	Freq2	T2 time Buzzer frequency, Unit 100 Hz Ranges: 0x05 ~ 0x32 (500Hz ~ 5KHz) 0x00 = T1 time period buzzer turn off

Note:

1. The buzzer sound time is (T1 + T2)*100ms

4.2.12 Flash_write (0x90)

seq	Cmd-code / Par-data	Descriptions
1	0x90	Write data to the flash at specified address
2	Address3(MSB)	the specified start address to write Address range =0x00000 ~ 0x03FFFF
3	Address2	
4	Address1	
5	Address0(LSB)	
6	Data_Lengthh	The no. of data byte to write. Length =0x0001 ~ 0x0400
7	Data_Lengthl	
8	Data	data to write.
:	:	
:	:	
:	:	

Note.

*1. Command should be transferred in communication packet structure (see Communication Packet Structure Section for details)

4.2.13 Flash_read (0x91)

seq	Cmd-code / Par-data	Descriptions
1	0x91	Read data from the flash at specified address
2	Address3(MSB)	the specified start address to write Address range =0x00000 ~ 0x03FFFF
3	Address2	
4	Address1	
5	Address0(LSB)	
6	Data_Lengthh	The no. of data byte to read Length =0x0001 ~ 0x0400
7	Data_Lengthl	

Note.

*1. Command should be transferred in communication packet structure (see Communication Packet Structure Section for details)

Response code:

Seq.	Content	Byte in Hex	Descriptions
1 st	Header	0xAA	Communication packet header
2 nd	Command	0x91	Command executed
3 rd	Data	data	Read back data
:		:	
:		:	
:	Tail	0xCC	Communication packet tail
:		0x33	
:		0xC3	
:		0x3C	
:			

Note.

*1. The Response code with communication packet format (see Communication Packet Structure Section for details)

4.2.14 RTC_read (0x9B)

seq	Cmd-code / Par-data	Descriptions
1	0x9B	Read the current RTC value

Response code:

Seq.	Content	Byte in Hex	Descriptions	
1 st	Header	0xAA	Communication packet header	
2 nd	Command	0x9B	Command executed	
3 rd	Date	Year	Year: 00~99 (00=year 2000) (8bit binary value)	
4 th		Month		Month: 01~12 (8bit binary value)
5 th		Day		Day: 01~31 (8bit binary value)
6 th	Time	Hour	Hour 00~23 (24hr format)(8bit binary value)	
7 th		Minute		Minutes 00~59 (8bit binary value)
8 th		Second		Second 00~59 (8bit binary value)
9 th	Tail	0xCC	Communication packet tail	
10 th		0x33		
11 th		0xC3		
12 th		0x3C		

Note.

*1. The Response code with communication packet format (see Communication Packet Structure Section for details)

4.2.15 RTC_set (0x9C)

seq	Cmd-code / Par-data	Descriptions
1	0x9C	Set the RTC
2	Year	Year = 00~99(2000 ~ 2099) Month = 00~12 Date = 00~31 Hour = 00~23 Minute = 00~59 Second = 00~59
3	Month	
4	Date	
5	Hour	
6	Minute	
7	Second	

Note.

*1. Command should be transferred in communication packet structure (see Communication Packet Structure Section for details)

4.2.16 USR_bin_read (0x93)

seq	Cmd-code / Par-data	Descriptions
1	0x93	Read USR_bin data from the flash at specified address
2	Address3(MSB)	the specified start address to write Address range = 0x00000 ~ 0x03FFFF
3	Address2	
4	Address1	
5	Address0(LSB)	
6	Data_Lengthh	The no. of data byte to read Length = 0x0001 ~ 0x0400
7	Data_Lengthl	

Note.

*1. Command should be transferred in communication packet structure (see Communication Packet Structure Section for details)

Response code:

Seq.	Content	Byte in Hex	Descriptions
1 st	Header	0xAA	Communication packet header
2 nd	Command	0x93	Command executed
3 rd	Data	data	Read back data
:		:	
:		:	
:	Tail	0xCC	Communication packet tail
:		0x33	
:		0xC3	
:		0x3C	

Note.

*1. The Response code with communication packet format (see Communication Packet Structure Section for details)

4.2.17 U_drv_format (0xE2)

seq	Cmd-code / Par-data	Descriptions
1	0xE2	Format the USB drive. All the files (include the security lock file) will be erased.
2	0x55	
3	0xAA	
4	0x5A	
5	0xA5	

Note.

*1. Command should be transferred in communication packet structure (see Communication Packet Structure Section for details)

4.2.18 U_drv_unlock (0xE3)

seq	Cmd-code / Par-data	Descriptions
1	0xE3	Unlock the USB drive of file read/write with pre-stored password.
2	PW	PW: password in ASCII Length = 127max. '\0'(0x00): string end mark
:	:	
:	:	
:	'\0'	

Note.

*1. Command should be transferred in communication packet structure (see Communication Packet Structure Section for details)

4.3 Display Control Function Commands Details

4.3.1 disp_page (0x70)

seq	Cmd-code / Par-data	Descriptions
1	0x70	Display a pre-stored TML file(page)
2	Page_IDh	Page_ID = 0~999
3	Page_IDl	

Note.

*1. Command should be transferred in communication packet structure (see Communication Packet Structure Section for details)

4.3.2 set_element_fg (0x7E)

Seq	Cmd-code / Par-data	Descriptions
1	0x7E	Set foreground colors of the STR, N16, N32 or N64
2	Element	0x00 = STR; 0x01 = N16, N32, N64
3	Page_IDh	
4	Page_IDl	Page_ID = 0~999
5	Element_ID	VP_STR = 0~127; N16, N32, N64 = 0~119
6	0x00	Reserve
7	FGh	Foreground color(0~0xffff)
8	FGl	

Note.

*1. Command should be transferred in communication packet structure (see Communication Packet Structure Section for details)

4.3.3 set_element_bg (0x7F)

Seq	Cmd-code / Par-data	Descriptions
1	0x7F	Set background color of the STR, N16, N32 or N64
2	Element	0x00 = STR; 0x01 = N16, N32, N64
3	Page_IDh	
4	Page_IDl	Page_ID = 0~999
5	Element_ID	VP_STR = 0~127, N16, N32, N64 = 0~119
6	Mode	0x00: non transparent; 0x01 : transparent
7	BGh	Background color(0 ~ 0xffff)
8	BGl	

Note.

*1. Command should be transferred in communication packet structure (see Communication Packet Structure Section for details)

4.3.4 set_codepage (0xE7)

Seq	Cmd-code / Par-data	Descriptions
1	0xE7	Sets country character set and code-page character set
2	Country	1 ~ 11, country character set
3	Codepage	1 ~ 22, code-page character set

Note.

*1. Country and CodePage table

Country Code	Descriptions	Code Page	Descriptions
1	USA	1	437 (OEM – United States)
2	France	2	737 (OEM – Greek 437G)
3	Germany	3	852 (OEM – Latin II)
4	United Kingdom	4	860 (OEM – Portuguese)
5	Demark I	5	863 (OEM – Canadian French)
6	Demark II	6	865 (OEM – Nordic)
7	Sweden	7	866 (OEM – Russian)
8	Italy	8	874 (ANSI/OEM – Thai)
9	Spain	9	932 (ANSI/OEM – Japanese Shift-JIS)
10	Japan	10	1250 (ANSI - Central Europe)
11	Norway	11	1251 (ANSI – Cyrillic)
--	--	12	1252 (ANSI – Latin I)
--	--	13	1253 (ANSI – Greek)
--	--	14	1254 (ANSI – Turkish)
--	--	15	1255 (ANSI – Hebrew)
--	--	16	1256 (ANSI – Arabic)
--	--	17	1257 (ANSI – Baltic)
--	--	18	1258 (ANSI – Viet Nam)
--	--	19	GB2312
--	--	20	GBK
--	--	21	EUC_KR
--	--	22	Big5

4.3.5 suspend_vp_refresh (0xE8)

Seq	Cmd-code / Par-data	Descriptions
1	0xE8	Set the screen to pause the refresh and deactivate the touchkey or release the pause to refresh and enable the touchkey
2	55	
3	AA	
4	5A	
5	A5	
6	Mode	0x00: release the pause to refresh and enable the touchkey 0x01: pause the refresh and deactivate the touchkey

Note.

*1. Command should be transferred in communication packet structure (see Communication Packet Structure Section for details)

4.4 VP Function Commands Details

4.4.1 Successive_write (0x82)

Seq	Cmd-code / Par-data	Descriptions
1	0x82	Write successive value to VP_N16, VP_N32, VP_N64
2	Addr3(MSB)	VP_N16 Address = 0x080000 ~ 0x08FFFF (should be aligned every 2 byte)
3	Addr2	
4	Addr1	VP_N32 Address = 0x020000 ~ 0x02FFFF (should be aligned every 4 byte)
5	Addr0(LSB)	VP_N64 Address = 0x030000 ~ 0x03FFFF (should be aligned every 8 byte)
6	Length	The number of data to write (Length = 1~255)
7	Data 1(MSB)	the value to write
8	Data 2	No. of byte of Data: VP_N16 = Length *2, VP_N32 = Length *4, VP_N64 = Length *8,
9	Data 3	
:	:	
:	Data n(LSB)	
:		

Note.

*1. Command should be transferred in communication packet structure (see Communication Packet Structure Section for details)

4.4.2 Successive_read (0x83)

Seq	Cmd-code / Par-data	Descriptions
1	0x83	Read successive value to VP_N16, VP_N32, VP_N64
2	Addr3(MSB)	VP_N16 Address = 0x080000 ~ 0x08FFFF (should be aligned every 2 byte)
3	Addr2	
4	Addr1	VP_N32 Address = 0x020000 ~ 0x02FFFF (should be aligned every 4 byte)
5	Addr0(LSB)	VP_N64 Address = 0x030000 ~ 0x03FFFF (should be aligned every 8 byte)
6	Length	The number of data to write (Length = 1 ~ 255)

Note.

*1. Command should be transferred in communication packet structure (see Communication Packet Structure Section for details)

Response code:

Seq.	Content	Byte in Hex	Descriptions	
1 st	Header	0xAA	Communication packet header	
2 nd	Command	0x83	Command executed	
3 rd	VP_ADD	Addr3(MSB)	VP Address	
4 th		Addr2		0x080000 ~ 0x08FFFF:VP_N16 Address
5 th		Addr1		0x020000 ~ 0x02FFFF:VP_N32 Address
6 th		Addr0(LSB)		0x030000 ~ 0x03FFFF:VP_N64 Address
7 rd	Length	NO.	No. of data	
8 rd	Data	Data n(MSB)	No. of byte of Data: VP_N16 = Length *2, VP_N32 = Length *4, VP_N64 = Length *8,	
:		:		
:		:		
(n-1) th		Data1		
n th		Data0(LSB)		
(n+1) th	Tail	0xCC	Communication packet tail	
(n+2) th		0x33		
(n+3) th		0xC3		
(n+4) th		0x3C		

Note.

*1. The Response code with communication packet format (see Communication Packet Structure Section for details)

4.4.3 BP1_write (0x4B)

Seq	Cmd-code / Par-data	Descriptions
1	0x4B	Write raw bit-map data to the VP_BP1
2	Addr3(MSB)	VP_BP1 Address = 0x040000 ~ 0x05FFFF
3	Addr2	
4	Addr1	
5	Addr0(LSB)	
6	Length3(MSB)	
7	Length2	
8	Length1	
9	Length0(LSB)	

Note.

- *1. Command should be transferred in communication packet structure (see Communication Packet Structure Section for details)
- *2. After the above command issued, it follow with the raw data byte with out communication packet structure.
- *3. over all command flow

HOST	Flow	module
BP1_write Command (in communication packet structure)	→	Instruct to wait for data....
Raw 1bpp image data (without communication packet structure)	→	Store the data into VP_BP1
	←	Response code ":@" in ASCII (without communication packet structure)

4.4.4 BP1_write_compress (0x4C)

Seq	Cmd-code / Par-data	Descriptions
1	0x4C	Write compressed bit-map data to the VP_BP1
2	Addr3(MSB)	VP_BP1 Address = 0x040000 ~ 0x05FFFF
3	Addr2	
4	Addr1	
5	Addr0(LSB)	
6	Length3(MSB)	
7	Length2	
8	Length1	
9	Length0(LSB)	

Note.

- *1. Command should be transferred in communication packet structure (see Communication Packet Structure Section for details)
- *2. After the above command issued, it follow with the compressed data byte with out communication packet structure.
- *3. over all command flow

HOST	Flow	module
BP1_write Command (in communication packet structure)	→	Instruct to wait for data....
compressed 1bpp image data (without communication packet structure)	→	Store the data into VP_BP1
	←	Response code ":@" in ASCII (without communication packet structure)

4.4.5 G16_write (0x4D)

Seq	Cmd-code / Par-data	Descriptions
1	0x4D	Write graph values to the VP_G16 array
2	Addr1_H	VP_G16 Address = 0x060000 ~ 0x07FFFF
3	Addr1l	
4	Addr2h	
5	Addr2l	
6	Sizeh	
7	Sizel	
8	Data(MSB)	16 bit data array (no. of byte = 2x array-size)
9	Data(LSB)	
10	Data(MSB)	
11	Data(LSB)	
:	:	
:	:	
:	:	

Note.

*1. Command should be transferred in communication packet structure (see Communication Packet Structure Section for details)

*2. Array-size = no. of 16bit values

*3. Array-size suggest to be same at the size value defined in TML editor

4.4.6 G16_write_rotate (0x4E)

Seq	Cmd-code / Par-data	Descriptions
1	0x4E	Write graph values to the last position of VP_G16 array with rotation effect
2	Addr1_H	VP_G16 Address = 0x060000 ~ 0x07FFFF
3	Addr1_L	
4	Addr2_H	
5	Addr2_L	
6	Size_H	
7	Size_L	
8	Data(MSB)	16 bit data value to be add to the end-of-array
9	Data(LSB)	

Note.

*1. Command should be transferred in communication packet structure (see Communication Packet Structure Section for details)

*2. Array-size = no. of 16bit values

*3. Array-size suggest to be same at the value defined in TML editor

4.4.7 System Register Write (0x3B)

seq	Cmd-code / Par-data	Descriptions
1	0x3B	System Register Write Command
2	Addr3(MSB)	Timer_Ctrl0 Address = 0xFFFF00 : Timer_Ctrl7 Address = 0xFFFF07
3	Addr2	
4	Addr1	
5	Addr0(LSB)	
6	Data	

Note.

*1. Command should be transferred in communication packet structure (see Communication Packet Structure Section for details)

4.4.8 System Register Read (0x3C)

seq	Cmd-code / Par-data	Descriptions
1	0x3C	System Register Read Command
2	Addr3(MSB)	Address = 0xFFFF00 : Address = 0FFFFFFF
3	Addr2	
4	Addr1	
5	Addr0(LSB)	

Note.

*1. Command should be transferred in communication packet structure (see Communication Packet Structure Section for details)

Response code:

Seq.	Content	Byte in Hex	Descriptions
1 st	Header	0xAA	Communication packet header
2 nd	Command	0x3C	Command executed
3 rd	Address	Addr3(MSB)	Address = 0xFFFF00 : Address = 0FFFFFFF
4 th		Addr2	
5 th		Addr1	
6 th		Addr0(LSB)	
7 th	Data	Data(1Byte)	the value of the register
8 th	Tail	0xCC	Communication packet tail
9 th		0x33	
10 th		0xC3	
11 th		0x3C	

Note.

*1. The Response code with communication packet format (see Communication Packet Structure Section for details)

*2. When Timer reach the 0x00000000 or 0x7FFFFFFF, a notification will be provided a 0x77 response code with the corresponding Timer Address and Value.(See touch_response(0x77)for details)

4.4.9 STR_write (0x42)

Seq	Cmd-code / Par-data	Descriptions
1	0x42	Write string to VP_STR
2	Addr3(MSB)	the VP_STR Address = 0x00000 ~ 0x01FFFF (each VP_STR = 128 bytes) (address value must be divisible by 128)
3	Addr2	
4	Addr1	
5	Addr0(LSB)	
6	data	
:	:	String to write Total no. of byte in string ≤128
:	:	
:	'\0'	

Note.

*1. Command should be transferred in communication packet structure (see Communication Packet Structure Section for details)

4.4.10 STR_read (0x43)

Seq	Cmd-code / Par-data	Descriptions
1	0x43	Read string from VP_STR
2	Addr3(MSB)	the VP_STR Address = 0x00000 ~ 0x01FFFF (each VP_STR = 128 bytes) (address value must be divisible by 128)
3	Addr2	
4	Addr1	
5	Addr0(LSB)	

Note.

*1. Command should be transferred in communication packet structure (see Communication Packet Structure Section for details)

Response code:

Seq.	Content	Byte in Hex	Descriptions
1 st	Header	0xAA	Communication packet header
2 nd	Command	0x43	Command executed
3 rd	String data	data	String code
:		:	
:		:	
:	\0	0x00	'\0'(0x00): string end mark
:	Tail	0xCC	Communication packet tail
:		0x33	
:		0xC3	
:		0x3C	

Note.

*1. The Response code with communication packet format (see Communication Packet Structure Section for details)

4.4.11 STR_fill (0x46)

Seq	Cmd-code / Par-data	Descriptions
1	0x46	Write string to VP_STR
2	Addr3(MSB)	the VP_STR Address = 0x00000 ~ 0x01FFFF (each VP_STR = 128 bytes) (address value must be divisible by 128)
3	Addr2	
4	Addr1	
5	Addr0(LSB)	
6	Lengthh	
7	Lengthl	
8	data	String to write
:	:	Total no. of byte in string ≤128
:	:	
:	'\0'	'\0'(0x00): string end mark

Note.

*1. Command should be transferred in communication packet structure (see Communication Packet Structure Section for details)

4.4.12 N16_write (0x3D)

Seq	Cmd-code / Par-data	Descriptions
1	0x3D	Write 16bit number to VP_N16
2	Addr3(MSB)	VP_N16 Address = 0x080000 ~ 0x08FFFF (each VP_N16 = 2 byte) (address value must be divisible by 2)
3	Addr2	
4	Addr1	
5	Addr0(LSB)	
6	High Byte	
7	Low Byte	

Note.

*1. Command should be transferred in communication packet structure (see Communication Packet Structure Section for details)

4.4.13 N16_read (0x3E)

Seq	Cmd-code / Par-data	Descriptions
1	0x3E	Read 16bit number from VP_N16
2	Addr3(MSB)	VP_N16 Address = 0x080000 ~ 0x08FFFF (each VP_N16 = 2 byte) (address value must be divisible by 2)
3	Addr2	
4	Addr1	
5	Addr0(LSB)	

Note.

*1. Command should be transferred in communication packet structure (see Communication Packet Structure Section for details)

Response code:

Seq.	Content	Byte in Hex	Descriptions
1 st	Header	0xAA	Communication packet header
2 nd	Command	0x3E	Command executed
3 rd	N16 value	Data1(MSB)	16 bit value
4 th		Data0(LSB)	
5 th	Tail	0xCC	Communication packet tail
6 th		0x33	
7 th		0xC3	
8 th		0x3C	

Note.

*1. The Response code with communication packet format (see Communication Packet Structure Section for details)

4.4.14 N16_fill (0x3F)

Seq	Cmd-code / Par-data	Descriptions
1	0x3F	Fill 16bit number to the VP_N16
2	Addr3(MSB)	VP_N16 Address = 0x080000 ~ 0x08FFFF (each VP_N16 = 2 byte) (address value must be divisible by 2)
3	Addr2	
4	Addr1	
5	Addr0(LSB)	
6	Lengthh	
7	Lengthl	
8	High Byte	the 16 bit value to fill
9	Low Byte	

Note.

*1. Command should be transferred in communication packet structure (see Communication Packet Structure Section for details)

4.4.15 N32_write (0x44)

Seq	Cmd-code / Par-data	Descriptions
1	0x44	Write 32bit number to VP_N32
2	Addr3(MSB)	VP_N32 Address = 0x020000 ~ 0x02FFFF (each VP_N32 = 4 byte) (address value must be divisible by 4)
3	Addr2	
4	Addr1	
5	Addr0(LSB)	
6	Data3(MSB)	
7	Data2	
8	Data1	
9	Data0(LSB)	

Note.

*1. Command should be transferred in communication packet structure (see Communication Packet Structure Section for details)

4.4.16 N32_read (0x45)

Seq	Cmd-code / Par-data	Descriptions
1	0x45	Read 32bit number from VP_N32
2	Addr3(MSB)	VP_N32 Address = 0x020000 ~ 0x02FFFF (each VP_N32 = 4 byte) (address value must be divisible by 4)
3	Addr2	
4	Addr1	
5	Addr0(LSB)	

Note.

*1. Command should be transferred in communication packet structure (see Communication Packet Structure Section for details)

Response code:

Seq.	Content	Byte in Hex	Descriptions
1 st	Header	0xAA	Communication packet header
2 nd	Command	0x45	Command executed
3 rd	N32 value	Data3(MSB)	32 bit value
4 th		Data2	
5 th		Data1	
6 th		Data0(LSB)	
7 th	Tail	0xCC	Communication packet tail
8 th		0x33	
9 th		0xC3	
10 th		0x3C	

Note.

*1. The Response code with communication packet format (see Communication Packet Structure Section for details)

4.4.17 N32_fill (0x47)

Seq	Cmd-code / Par-data	Descriptions
1	0x47	Fill 32bit number to the VP_N32
2	Addr3(MSB)	VP_N32 Address = 0x020000 ~ 0x02FFFF (each VP_N32 = 4 byte) (address value must be divisible by 4)
3	Addr2	
4	Addr1	
5	Addr0(LSB)	
6	Lengthh	
7	Lengthl	
8	Data3(MSB)	the 32 bit no. value to fill
9	Data2	
10	Data1	
11	Data0(LSB)	

Note.

*1. Command should be transferred in communication packet structure (see Communication Packet Structure Section for details)

4.4.18 N64_write (0x48)

Seq	Cmd-code / Par-data	Descriptions
1	0x48	Write 64bit number to VP_N64
2	Addr3(MSB)	VP_N64 Address= 0x030000 ~ 0x03FFFF (each VP_N64 = 8 byte) (address value must be divisible by 8)
3	Addr2	
4	Addr1	
5	Addr0(LSB)	
6	Data7(MSB)	
7	Data6	
:	:	
:	:	
12	Data1	
13	Data0(LSB)	

Note.

*1. Command should be transferred in communication packet structure (see Communication Packet Structure Section for details)

4.4.19 N64_read (0x49)

Seq	Cmd-code / Par-data	Descriptions
1	0x49	Read 64bit number from VP_N64
2	Addr3(MSB)	VP_N64 Address= 0x030000 ~ 0x03FFFF (each VP_N64 = 8 byte) (address value must be divisible by 8)
3	Addr2	
4	Addr1	
5	Addr0(LSB)	

Note.

*1. Command should be transferred in communication packet structure (see Communication Packet Structure Section for details)

Response code:

Seq.	Content	Byte in Hex	Descriptions
1 st	Header	0xAA	Communication packet header
2 nd	Command	0x49	Command executed
3 rd	N64 value	Data7(MSB)	64 bit value
4 th		Data6	
:		:	
:		:	
9 th		Data1	
10 th		Data0(LSB)	
11 th		Tail	
12 th	0x33		
13 th	0xC3		
14 th	0x3C		

Note.

*1. The Response code with communication packet format (see Communication Packet Structure Section for details)

4.4.20 N64_fill (0x4A)

Seq	Cmd-code / Par-data	Descriptions
1	0x4A	Fill 64bit number to the VP_N64
2	Addr3(MSB)	VP_N64 Address= 0x030000 ~ 0x03FFFF (each VP_N64 = 8 byte) (address value must be divisible by 8)
3	Addr2	
4	Addr1	
5	Addr0(LSB)	
6	Lengthh	
7	Lengthl	
8	Data7(MSB)	the 64 bit no. value to fill
9	Data6	
:	:	
:	:	
14	Data1	
15	Data0(LSB)	

Note.

*1. Command should be transferred in communication packet structure (see Communication Packet Structure Section for details)

Teriminal K1	
No.	Pin Name
1	VDD
2	RXD
3	TXD
4	RTS(BUSY)
5	NC
6	VSS

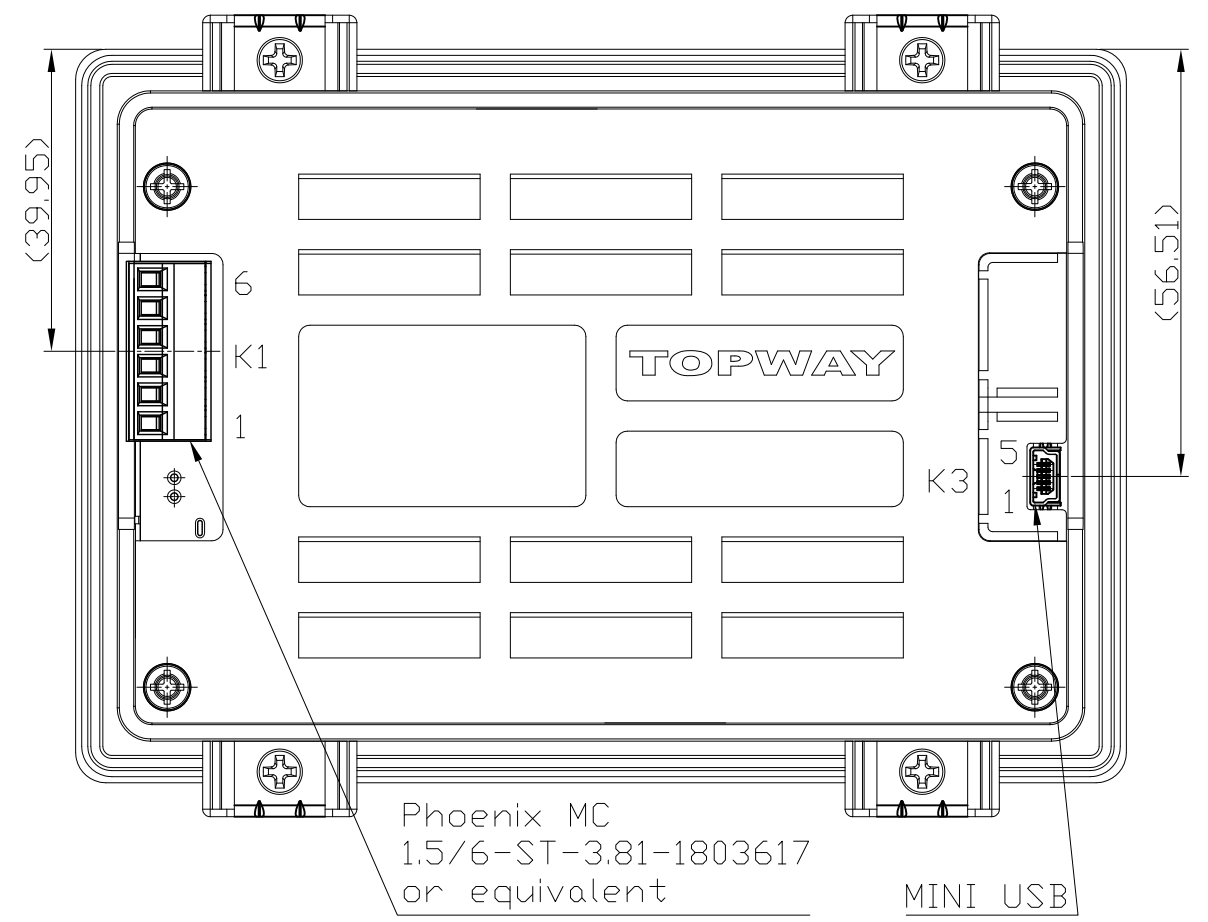
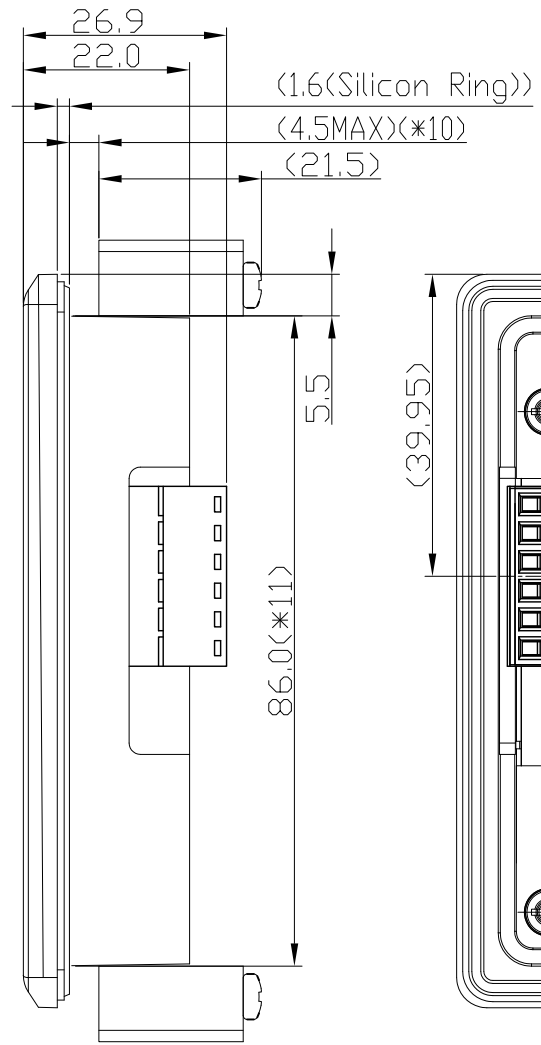
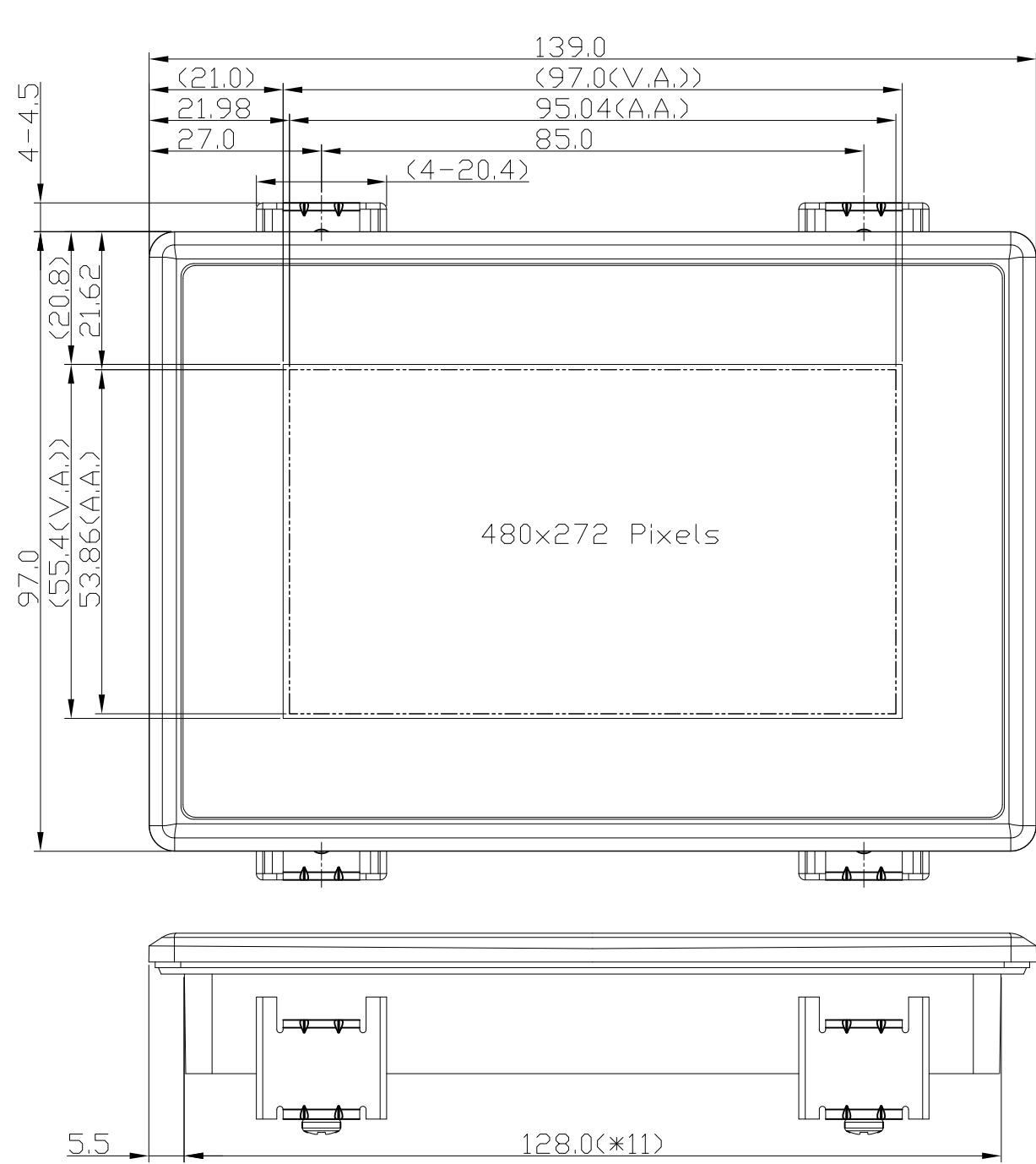

Phoenix MC
1.5/6-ST-3.81-1803617
or equivalent

MINI USB

Note:

- *1. LCD Display Type : TFT, Transmissive
- *2. Operating Voltage : Typ=12.0V (6.0~26.0V)
- *3. Backlight Color : White LEDs
- *4. Pixel Arrangement : RGB-STRIPE
- *5. Color Depth : 65k Colors
- *6. Interface : K1 RS-232C (P3.81x6pin Phoenix MC 1.5/6-ST-3.81-1803617 or equivalent)
K3 Mini USB
- *7. Touch Panel Type : Resistive Touch Panel
- *8. Operating Temperature : -20°C~70°C
- *9. Storage Temperature : -30°C~80°C
- *10. Applicable assemble panel thickness = 4.5MAX
- *11. Applicable assemble panel Opening (Min)

C		
B		
A		
Rev	Note	Date
Dwg Title HKT043ATA-1C Outline Dwg		
Dwg No.	MK-006097-1-1	Date 2017-07-03
Scale 1/1	Tol. ±0.5	Unit mm Paper Size A3
Approved	Checked	Drawn Qiu Shaoping

TOPWAY